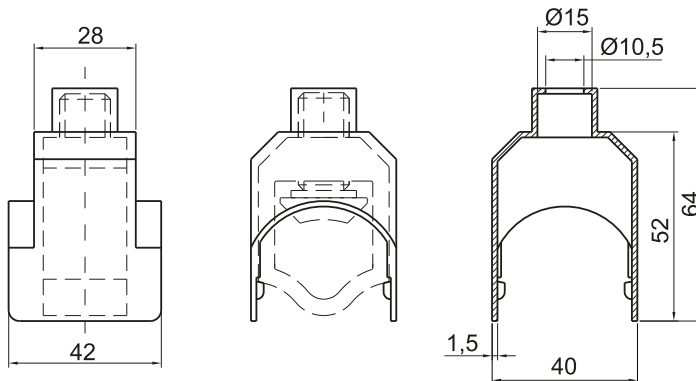
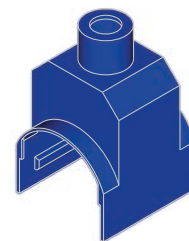
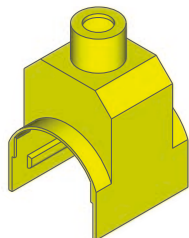
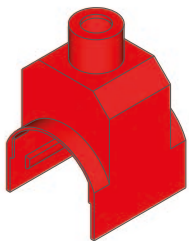
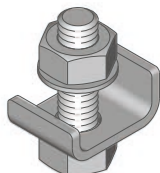
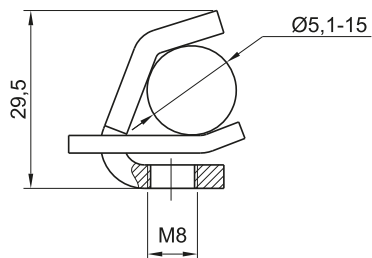
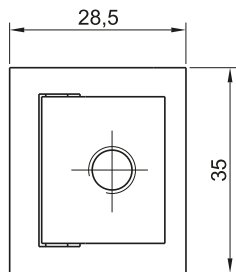
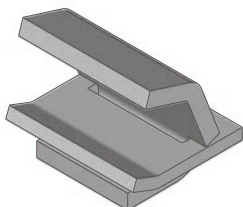
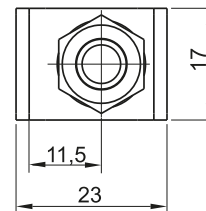
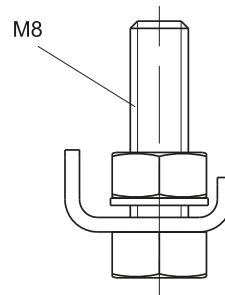

**V-KLEMY COVERS**

NAME	MATERIAL	COLORS
V-klema cover	PA6-polyamide	

**NOTICE:**

V-klema covers can be used with screw clamps type: 50-240SW, 70-300SW, 50-300SW i 35-240SW

**CLAMPS**
**4**
**LINEAR CLAMP - ZLG  
4.402.001**

**GOUND HOLDER  
4.403.001**

CTALOGUE NUMBER	NAME	MATERIAL
4.402.001	Linear clamp ZLG	Stainless steel
4.403.001	Ground clamp ZU	Stainless steel or steel zinc plated